

This manual describes installation, wiring, and other tasks required to make the indicator ready for operation.

Contents

- Safety Precautions
- Model and Suffix Codes
- How to Install
- How to Connect Wires
- Hardware Specifications
- Terminal Wiring Diagrams

Introduction

Thank you for purchasing the UM351/UM331 digital indicator with alarms. The indicator is shipped from the factory with 4 hardcopy user's manuals (A2 and A3 size). The 3 user's manuals in hardcopy format describe the operating procedures required for basic use. It is recommended that you refer to these user's manuals to understand [1] installation, [2] initial settings, and [3] operating procedures of the indicator.

How to Use the Manuals

Purpose	Manual Title	Description	Media
Setup	Installation	Describes the tasks (installation, wiring, and others) required to make the indicator ready for operations.	A2-size paper (Front and back)
Basic operation	Initial Settings	Describes examples of setting PV input types, and alarm types. Making settings described herein allows you to carry out basic monitoring.	A2-size paper (Front)
Operating procedures and troubleshooting	Operations	Describes examples of setting alarm setpoints, as well as key operation necessary to run the indicator	(Back)
Brief operation and pinpoint recording	Parameters	Contains the parameter map used as a guideline for setting parameters and lists of parameters for recording user settings.	A2-size paper (Front and back)
Basic operation of Active Color PV Display	Setting / explanation of Active Color PV Display	Describes the setting/explanation of Active Color PV Display	A3-size paper, back and front

1. Safety Precautions

The following symbol is indicated on the indicator to ensure safe use.

CAUTION

This symbol on the indicator indicates that the operator must refer to an explanation in the user's manual in order to avoid the risk of injury or death of personnel or damage to the instrument. The manual describes how the operator should exercise special care to avoid electric shock or other dangers that may result in injury or loss of life.

The following symbols are used in the hardcopy user's manuals.

NOTE

Indicates that operating the hardware or software in a particular manner may damage it or result in a system failure.

IMPORTANT

Draws attention to information that is essential for understanding the operation and/or features of the indicator.

Exemption from Responsibility

Make sure that all of the precautions are strictly adhered to. Yokogawa Electric Corporation assumes no liability for any damage resulting from use of the instrument in contradiction to the precautions. Also, Yokogawa Electric Corporation assumes no liability to any party for any loss or damage, direct or indirect, caused by the use of any unpredictable defect of the instrument.

Regarding Protection, Safety, and Prohibition Against Unauthorized Modification

- In order to protect the product and the system controlled by it against damage and ensure its safe use, make certain that all of the instructions and precautions relating to safety contained in this document are strictly adhered to. Yokogawa does not guarantee safety if products are not handled according to these instructions.
- Modification of the product is strictly prohibited.

2. Model and Suffix Codes

Before using the indicator, check that the model and suffix codes match your order.

Model	Suffix Code	Description
UM351		Digital indicator with Alarms (provided with retransmission output and 15 V DC loop power supply as standard)
UM331		Standard type with three alarms
Type	-0	Standard type with three alarms
	-3	Standard type with three alarms (with 24V DC loop power supply)
Optional functions	0	None
	1	With communication and additional alarm-4
	2	With additional alarm-4

Check that the following items are provided:

- Digital indicator with alarms (of ordered model): 1
- Brackets (mounting hardware): 1 pair
- Unit label: 1
- User's Manuals: 3 (A2 size)
- User's Manuals "Setting/Explanation of Active Color PV Display": 1 (A3 size)
- User's Manual (Reference) (CD-ROM Version) (only for indicators with optional communication functions): 1

3. How to Install

NOTE

To install the indicator, select a location where:

- no one may accidentally touch the terminals,
- mechanical vibrations are minimal,
- corrosive gas is minimal,
- temperature can be maintained at about 23°C and the fluctuation is minimal,
- no direct radiant heat is present,
- no magnetic disturbances are caused,
- no wind blows against the terminal board (reference junction compensation element),
- no water is splashed,
- no flammable materials are around.

Never place the indicator directly on flammable items or equipment. If the indicator has to be installed close to flammable items or equipment, be sure to provide shielding panels all around the indicator, at least 150mm away from every side; the panels should be made of either 1.43mm-thick metal-plated steel plates or 1.6mm-thick uncoated steel plates.

NOTE

Never touch the opening at the bottom of the case. It is to be used in the factory at shipping.

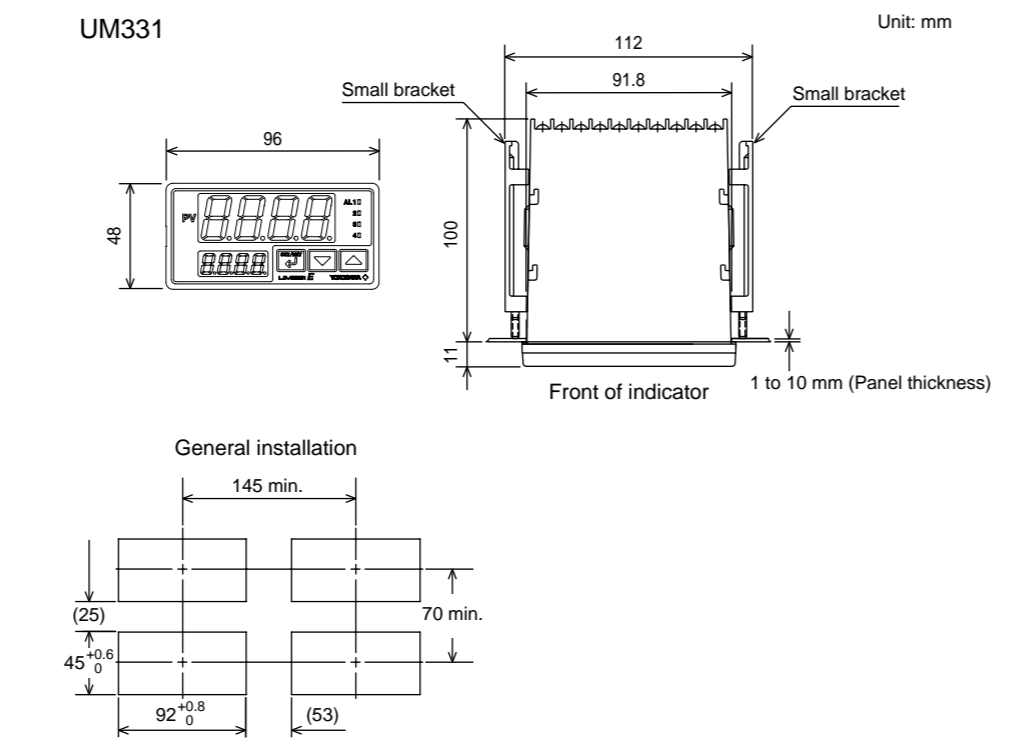
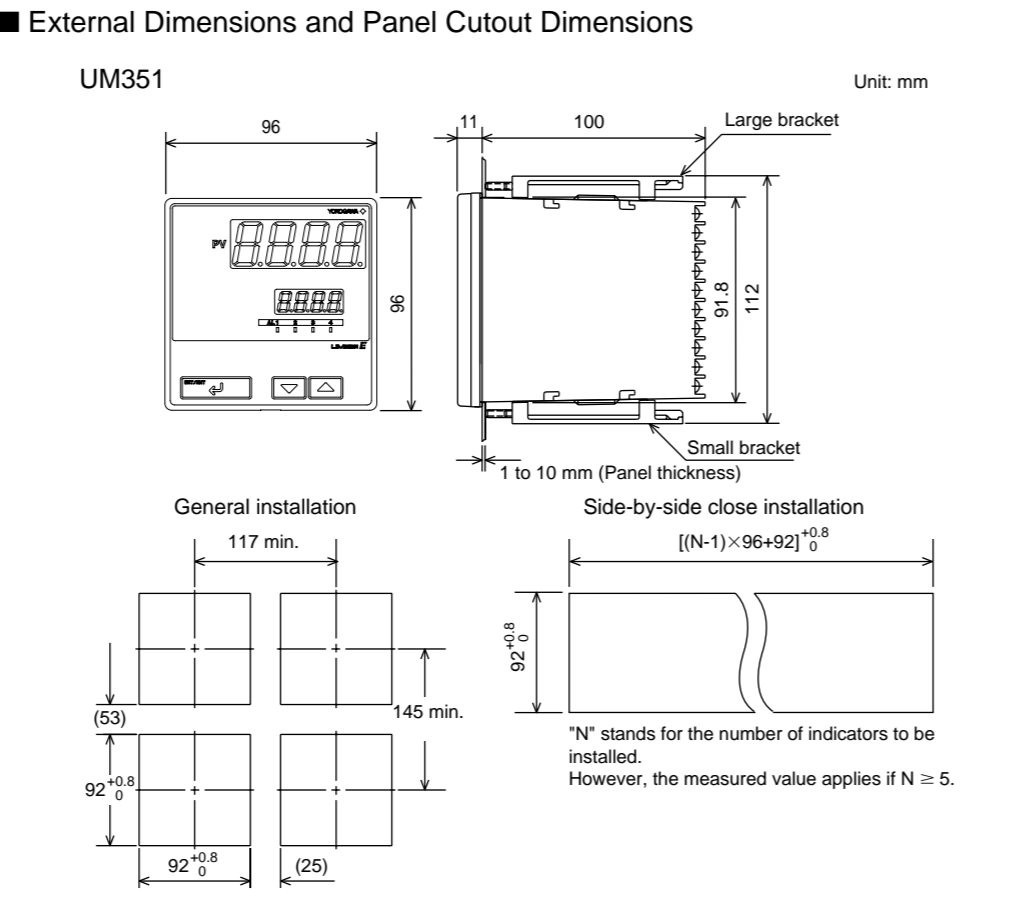
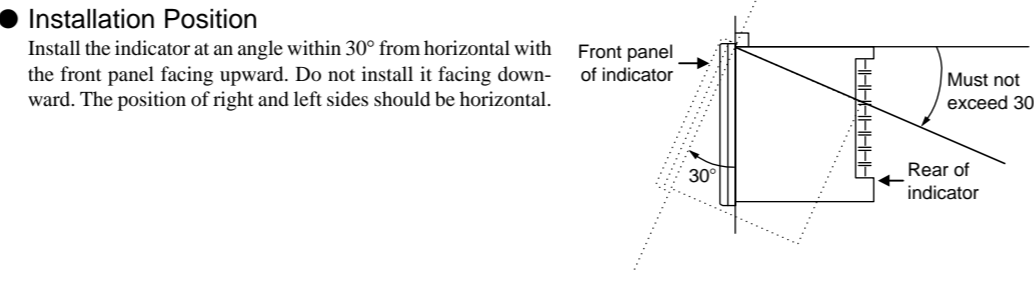

How to Install

CAUTION

Turn off the power to the indicator before installing it on the panel because there is a possibility of electric shock.

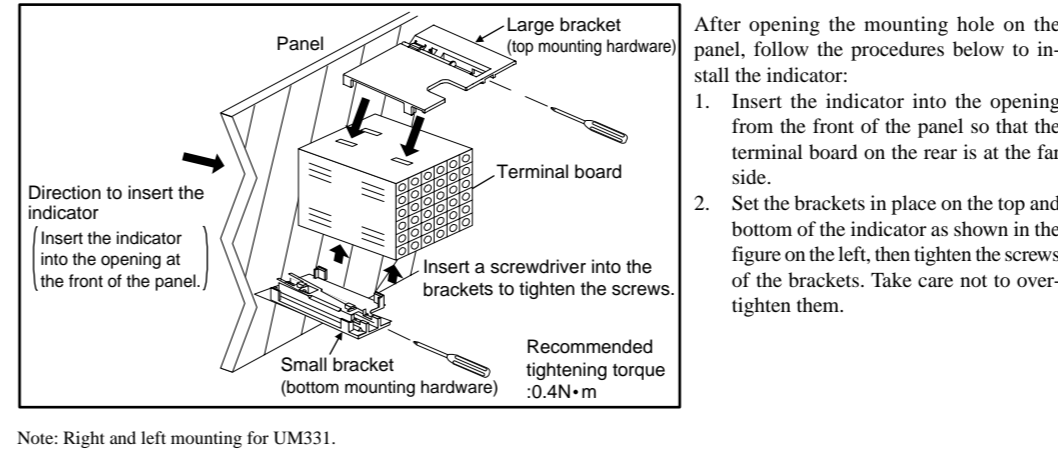

4. How to Connect Wires

CAUTION

- Before carrying out wiring, turn off the power to the indicator and check that the cables to be connected are not alive with a tester or the like because there is a possibility of electric shock.
- For the protection and safe use of the indicator, be sure to place a circuit breaker (conforms with IEC60947, 5A, 100V or 220V AC) near the indicator where the breaker can easily be operated. In addition, be sure to indicate that it is the instrument to cut the power supply of the indicator.
- Wiring must be carried out by personnel who have basic electrical knowledge and practical experience.

NOTE

- Provide power from a single-phase instrument power supply. If there is a lot of noise in the power line, insert an insulating transformer into the primary side of the line and use a line filter (recommended part: ZAC2205-00U from TDK) on the secondary side. As a countermeasure against noise, do not place the primary and secondary power cables close to each other. For thermocouple input, use shielded compensating lead wires for wiring. For RTD input, use shielded wires that have low conductor resistance and cause no significant differences in resistance between the three wires. The cables to be used for wiring, terminal specifications, and recommended parts are as shown below.
- Alarm output relays have a life of 100,000 times that of the resistance load, use auxiliary relays to turn on/off a load.
- The use of inductance (L) loads such as auxiliary relays, motors and solenoid valves causes malfunction or relay failure; always insert a CR filter for use with alternating current or a diode for use with direct current, as a spark-removal surge suppression circuit, into the line in parallel with the load.
- When there is possibility of being struck by external lightning surge, use the arrester to protect the instrument.

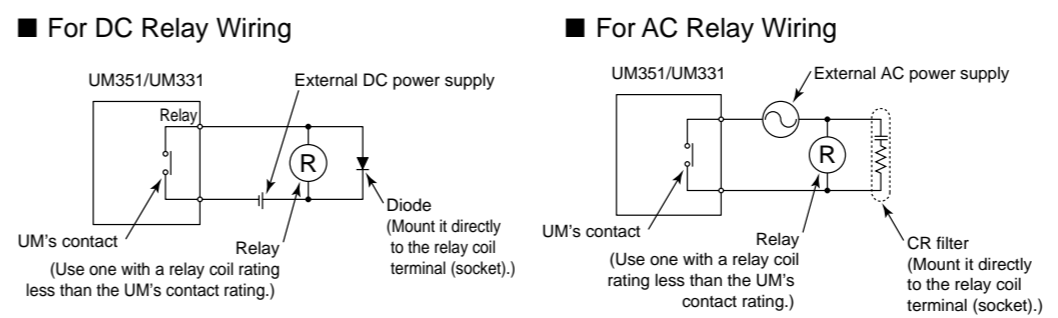

Cable Specifications and Recommended Cables

Purpose	Name and Manufacturer
Power supply, grounding, relay contact outputs	600 V PVC insulated wires, JIS C 3307, 0.9 to 2.0 mm ²
Thermocouple	Shielded compensating lead wires, JIS C 1610, □X-□-□-□ (See Yokogawa Electric's GS 6B1U1-E.)
RTD	Shielded wires (three conductors), UL2482 (Hitachi Cable)
Other signals	Shielded wires

Recommended Terminal Lugs

Applicable wire size	Tightening torque
0.3 to 1.65 mm ²	0.8 N·m or less

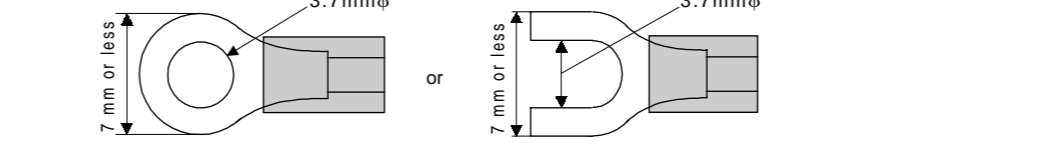

Terminal Covers(Optional parts)

Target Model	Part Number	Sales Unit
UM351	T9115YD	1
UM331	T9115YE	1

- Before attaching the terminal cover, bend the side with the groove inward as shown in Fig. A. Be careful not to bend it backwards. This not only marks it harder to attach the cover but will also weaken its hold.
- Fit the holes on the top and bottom (or left and right) of the terminal cover the projections on the brackets (Fig. B) and lock in place. The figure right shows the attachment of a terminal cover to UM indicator.

Note: Right and left mounting for UM331.

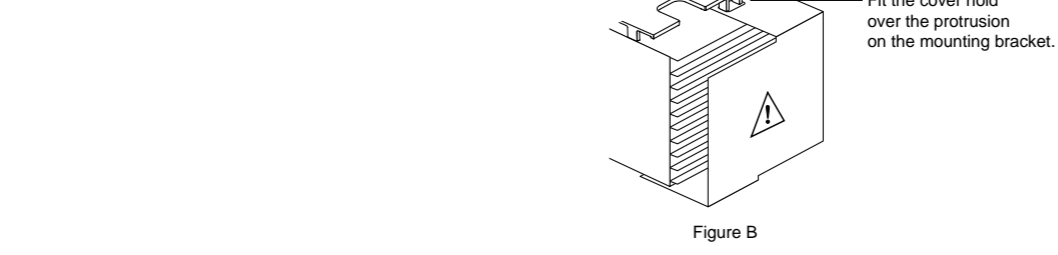

5. Hardware Specifications

PV Input Signals

- Number of inputs: 1 (terminals ①-③)
- Input type: Universal input system. The input type can be selected with the software.
- Sampling period: 250 ms
- Burnout detection: Functions at TC, RTD, standard signal (0.4 to 2 V or 1 to 5 V) upscale, downscale, and off can be specified. For standard signal, burnout is determined to have occurred if it is 0.1 V or less.
- Input bias current: 0.05 μA (for TC or RTD terminal)
- Measurement current (RTD): About 0.13 mA
- Input resistance: 1 MΩ or more for thermocouple or mV input
- About 1 MΩ for DC voltage input
- Effects of signal source resistance: 0.1 μV/Ω or less 2 kΩ or less for DC voltage input
- Effects of signal source resistance: About 0.01%/100 Ω
- Allowable wiring resistance: for RTD input
- Maximum 150 Ω/wire: Conductor resistance between three wires should be equal
- However, 10 Ω/wire for a maximum range of -150.0 to 150.0°C
- Wire resistance effect: ±0.1°C/10 Ω
- Allowable input voltage: ±10 V DC for thermocouple, mV, or RTD input
- ±20 V DC for DC voltage input
- Noise rejection ratio: 40 dB (50/60 Hz or more in normal mode 120 dB (50/60 Hz) or more in common mode
- Reference junction compensation error: ±1.0°C (15 to 35°C) ±1.5°C (0 to 15°C, 35 to 50°C)
- Applicable standards: JIS, IEC, DIN (ITS-90) for thermocouples and RTD

Construction, Installation, and Wiring

- Construction: Only the front panel is dust-proof and drip-proof (protection class IP55) For side-by-side close installation the indicator loses its dust-proof and drip-proof protection.
- Material: ABS resin and polycarbonate
- Case color: Black
- Weight: About 1 kg or less
- Dimensions:
 - UM351 —96(W) × 96(H) × 100(depth from panel face) mm
 - UM331 —96(W) × 48(H) × 100(depth from panel face) mm
- Installation: Panel-mounting type. With top and bottom (or right and left) mounting hardware (1 each)
- Panel cutout dimensions:
 - UM351 —92^{-0.8}(W) × 92^{-0.8}(H) mm
 - UM331 —92^{-0.6}(W) × 45^{-0.8}(H) mm
- Installation position: Up to 30° upward facing (not designed for facing downward)
- Wiring: M3.5 screw terminals (for signal wiring and power/ground wiring as well)

Power Supply Specifications

- Power supply: Rated voltage of 100 to 240 V AC (±10%), 50/60 Hz
- Power consumption: Max. 20 VA (8.0 W max.)
- Internal fuse rating: 250 V AC, 1.6A time-lag fuse
- Data backup: Non-volatile memory (can be written to up to 100,000 times)
- Withstanding voltage
 - Between primary terminals* and secondary terminals**:
 - Between primary terminals* and grounding terminal: At least 1500 V AC for 1 minute
 - Between grounding terminal and secondary terminals**:
 - At least 1500 V AC for 1 minute
 - Between secondary terminals**:
 - At least 500 V AC for 1 minute
- * Primary terminals indicate power terminals and relay output terminals
- ** Secondary terminals indicate analog I/O signal, and contact input terminals
- Insulation resistance: 20 MΩ or more at 500 V DC between power terminals and grounding terminal
- Grounding: Class D grounding (grounding resistance of 100 Ω or less)

Loop Power Supply

Power is supplied to a two-wire transmitter. (15 V DC: terminals ④-⑤; 24 V DC: terminals ⑥-⑦) A resistor (10 to 250 Ω) connected between the indicator and transmitter converts a current signal into a voltage signal, which is then read via the PV input terminal. Supply voltage: 14.5 to 18.0 V DC, max. 21 mA (provided with a protection circuit against a field short-circuit); 21.6 to 28.0 V DC, max. 30 mA (only for models with 24 V DC loop power supply)

0 to 40°C if the 24V DC loop power supply of Model UM331 is used

Retransmission Output

Outputs the PV value. Either the retransmission output or the loop power supply can be used with terminals ⑧-⑩.

- Number of outputs: 1 (terminals ⑧-⑩)
- Output signal: 4-20 mA DC
- Load resistance: 600 Ω or less
- Output accuracy: ±0.3% of span under standard operating conditions (23 ±2°C, 55 ±10% RH, power frequency of 50/60 Hz)

Contact Inputs

- Purpose: Resetting of PV peak and bottom values
- Number of inputs: 1
- Input type: Non-voltage contact or transistor open collector input
- Input contact rating: 12 V DC, 10 mA or more
- On/off determination: For non-voltage contact input, contact resistance of 1 kΩ or less is determined as "on" and contact resistance of 20 kΩ or more as "off."
- For transistor open collector input, input voltage of 2 V or less is determined as "on" and leakage current must not exceed 100 μA when "off."
- Minimum status detection hold time: About 1 second

Contact Outputs

- Purpose: Alarm output, FAIL output, and others
- Number of outputs: 4 (Max.)
- Relay contact rating for Alarm 1 to 3: 240 V AC, 1 A, or 30 V DC, 1 A ; 1a (FAIL output : 1b)
- Relay contact rating for Alarm 4: 250 V AC, 3 A, or 30 V DC, 3 A (resistance load) 3 terminals (NC, NO, Common); 1c

Display Specifications

- PV display: 4-digit, 7-segment green or red LED display, character height of 20 mm (for both UM351 and UM331)
- Setpoint display: 4-digit, 7-segment, red LEDs, character height of 9.3 mm (for both UM351 and UM331)
- Status indicating lamps: LEDs

Safety and EMC Standards

- Safety: Compliant with IEC/EN61010-1: 2001, approved by CSA1010, approved by UL508
- Installation category : CAT II (IEC/EN61010, CSA1010)
- Pollution degree : 2 (IEC/EN61010, CSA1010)
- Measurement category : 1 (CAT. I : IEC/EN61010)
- Rated measurement input voltage : 10V DC max.(across terminals), 300V AC max.(across ground)
- Rated transient overvoltage : 1500V (Note)
- Note : It is a value on the safety standard which is assumed by IEC/EN61010-1 in measurement category I, and is not the value which guarantees an apparatus performance.

CAUTION

This equipment has Measurement category I, therefore do not use the equipment for measurements within measurement categories II, III and IV.

Measurement category	Description	Remarks
I	CAT. I For measurements performed on circuits not directly connected to M.A.I.N.	
II	CAT. II For measurements performed on circuits directly connected to the low voltage installation.	Appliances, portable equipments, etc.
III	CAT. III For measurements performed in the building installation.	Distribution board, local busbar, etc.
IV	CAT. IV For measurements performed at the source of the low-voltage installation.	Overhead wire, cables systems, etc.



EMC standards: Complies with EN61326. The instrument continues to operate at a measuring accuracy of within ±20% of the range during tests.

6. Terminal Wiring Diagrams

NOTE
Do not use unassigned terminals as relay terminals.

UM351 Standard Type (Model UM351-□□)

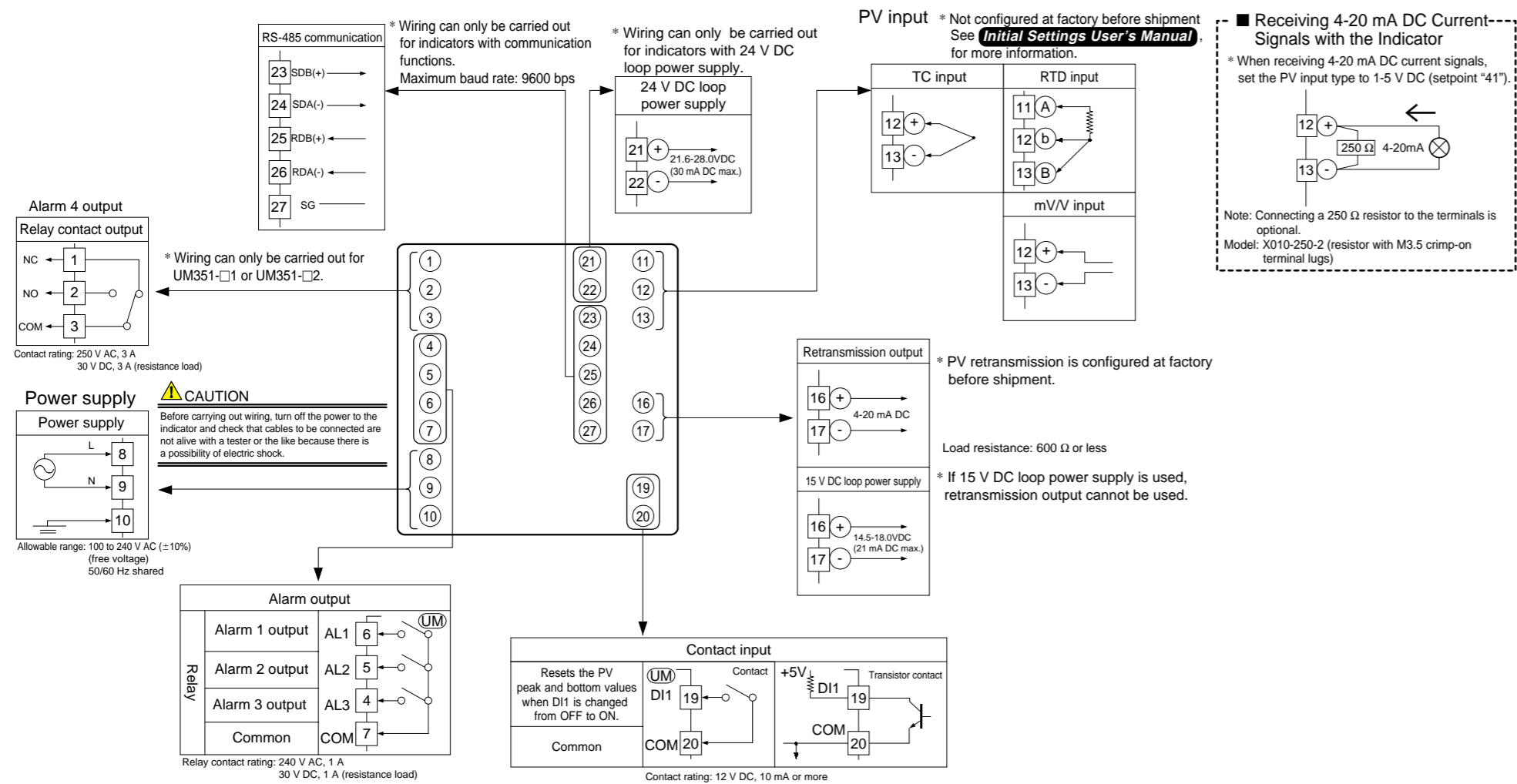

UM331 Standard Type (Model UM331-□□)

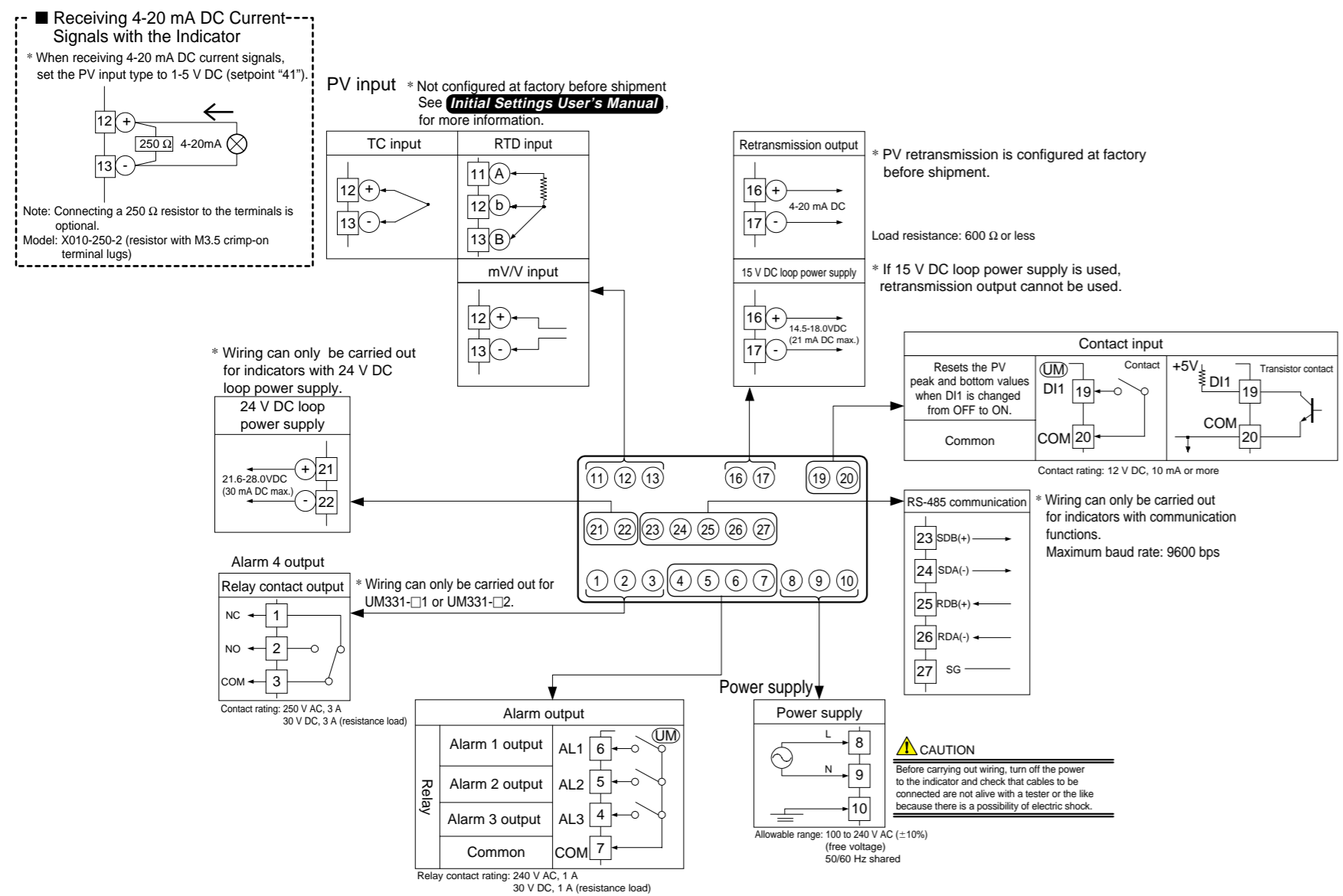

15 V DC Power Supply Wiring to Two-wire Sensor

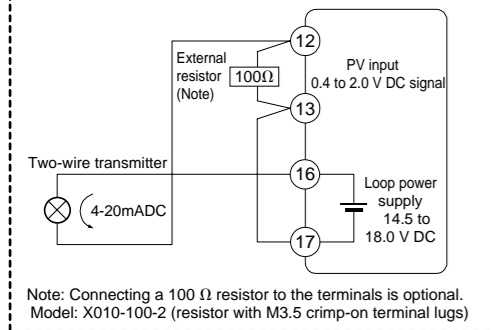

24 V DC Power Supply Wiring to Two-wire Sensor

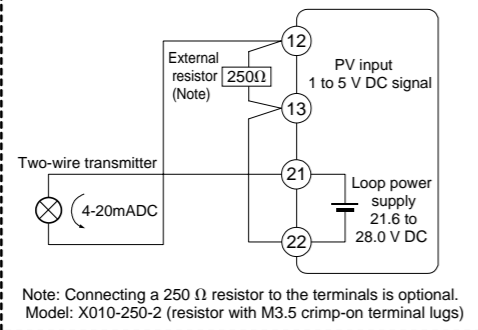

This manual describes examples of setting the types of PV input and alarm. Carrying out settings described herein allows you to perform basic monitoring. Refer to examples of various settings to understand how to set parameters required. Refer to "1. Parameter Map" in **Parameters User's Manual** for an easy to understand explanation of setting various parameters. If you cannot remember how to carry out an operation during setting, press the key for more than 3 seconds. This brings you to the display (operating display) that appears at power-on.

Contents

- Names and Functions of Front Panel Parts
- Setting PV Input Type (Setting First at Power-on)
- Changing PV Input Type
- Changing Alarm Type
- Setting Hysteresis in Alarm Setpoint

1. Names and Functions of Front Panel Parts

1. Process variable (PV) display
 2. Parameter Setpoint display
 3. Alarm indicator lamps
 4. SET/ENT key
 5. ∇ and Δ keys

Name of Part	Function
1. Process variable (PV) display	• Displays a PV value during operation. • Displays a parameter symbol when you set a parameter. • Displays an error code in red if the indicator fails.
2. Parameter setpoint display	Displays the setpoint of a parameter when it is configured.
3. Alarm indicator lamps	If any of alarms 1 to 4 occurs, the respective alarm indicator lamp (AL1 to AL4) is lit (in orange).
4. SET/ENT key	Used to switch or register a parameter. Pressing the key for more than 3 seconds allows you to switch between the operating display and the menu for operating parameter setting display alternately.
5. ∇ and Δ keys	Used to change numerical values. On setting displays for various parameters, you can change parameters, setpoint. Pressing the ∇ key decreases a numerical value, while pressing the Δ key causes it to increase. You can hold down a key to gradually increase the speed of change.

The following explanation of operation for the UM351's panel, shown in the figure, is the same as that of the UM331's panel.

IMPORTANT

The indicator automatically returns to the display at the time of power-on (i.e., Operating display) if no key is operated for at least one minute.

2. Setting PV Input Type (Setting First at Power-on)

NOTE

- The indicator displays the operating display when the power is turned on. However, if PV input type has not been set, "IN" appears. In this case, first use the key to display the input range code to use, then press the key to register it. Then, set the maximum value (RH) and minimum value (RL) of the PV input range (for voltage input, set the maximum value (SH) and minimum value (SL) of the PV input scale).
- The indicator is configured to the initial value of each parameter at the factory before shipment. First check the initial values shown in 2. Lists of Parameters, in **Parameters User's Manual** and change parameter values as necessary.

Example of Temperature Input
 -200°C to 1370°C
 Instrument input range: -200 to 1370
 PV input range: 0 to 800
 Minimum value of PV input range (RL): 0
 Maximum value of PV input range (RH): 800

Example of Voltage Input
 0.0mV to 50.0mV
 Instrument input range: 0 to 50
 PV input scale: 0.0 to 50.0
 Minimum value of PV input scale (SL): 0.0
 Maximum value of PV input scale (SH): 50.0

Parameters to be set for temperature input:
 1. PV input type (IN): Set according to a sensor.
 2. Maximum value of PV input range (RH): Set the maximum value of the range to be displayed.
 3. Minimum value of PV input range (RL): Set the minimum value of the range to be displayed.

Parameters to be set for voltage input:
 1. PV input type (IN): Set according to an input signal.
 2. Maximum value of PV input range (RH): Set the maximum value of an input signal.
 3. Minimum value of PV input range (RL): Set the minimum value of an input signal.
 4. Position of PV input decimal point (SDP): Set the position of the decimal point for PV input display.
 5. Maximum value of PV input scale (SH): Set the maximum value of the scale to be displayed.
 6. Minimum value of PV input scale (SL): Set the minimum value of the scale to be displayed.

The following operating procedure describes an example of setting a K-type thermocouple (-199.9°C to 500.0°C) and a measurement range of 0.0°C to 200.0°C.

1. Display screen at power-on. The parameter "IN" for setting the PV input type appears.

2. Press the or key to display the required setpoint. The figure below shows an example of setting a K-type thermocouple (-199.9 to 500.0°C). See the Instrument Input Range Codes.

3. Press the key once to register the setpoint.

4. Press the key once to display the parameter "UNIT" (PV input unit).

5. Press the key once to display the parameter "RH" (maximum value of PV input range).

6. Press the key to display required the setpoint. The figure below shows an example of setting the maximum value of PV input range to 200.0°C.

7. Press the key once to register the setpoint.

8. Press the key once to display the parameter "RL" (minimum value of PV input range).

9. Press the or key to display the required setpoint. The figure below shows an example of setting the minimum value of PV input range to 0.0°C.

10. Press the key once to register the setpoint.

11. Press the key for more than 3 seconds. This returns you to the display shown at power-on (figure below).

If the type of input is voltage, also configure the PV Input Decimal Point Position (SDP), Maximum value of PV Input Scale (SH), and Minimum value of PV Input Scale (SL) parameters that are displayed after this.

Instrument Input Range Codes

Input	Type	Instrument Input Range Code	Instrument Input Range	Measurement Accuracy
Unspecified		OFF	Set the data item PV Input Type "IN" to the OFF option to leave the PV input type undefined.	
Thermocouple	K	1	-200 to 1370°C -300 to 2500°F	±0.1% of instrument range ±1 digit for temperatures equal to or higher than 0°C ±0.2% of instrument range ±1 digit for temperatures below 0°C
		2	-199.9 to 999.9°C 0 to 2300°F	
		3	-199.9 to 500.0°C -199.9 to 999.9°F	
		4	-199.9 to 999.9°C -300 to 2300°F	
		5	-199.9 to 400.0°C -300 to 750°F	
		6	0.0 to 400.0°C -199.9 to 750.0°F	
Thermocouple	J	7	0 to 1800°C 32 to 3300°F	±0.15% of instrument range ±1 digit for temperatures equal to or higher than 400°C ±5% of instrument range ±1 digit for temperatures below 400°C
		8	0 to 1700°C 32 to 3100°F	
		9	0 to 1700°C 32 to 3100°F	
		10	-200 to 1300°C -300 to 2400°F	
		11	-199.9 to 999.9°C -300 to 1800°F	
		12	-199.9 to 900.0°C -300 to 1300°F	
		13	-199.9 to 400.0°C -300 to 750°F	
		14	0.0 to 400.0°C -199.9 to 750.0°F	
		15	0 to 2300°C 32 to 4200°F	
RTD	Pt100	16	0 to 1390°C 32 to 2500°F	±0.1% of instrument range ±1 digit ±0.5% of instrument range ±1 digit for temperatures equal to or higher than 800°C No guarantee of accuracy for temperatures below 800°C
		17	0 to 1900°C 32 to 3400°F	
		18	0 to 2000°C 32 to 3600°F	
		19	-199.9 to 500.0°C -199.9 to 999.9°F	
		20	-150.0 to 150.0°C -199.9 to 300.0°F	
		21	-199.9 to 850.0°C -300 to 1560°F	
		22	-199.9 to 500.0°C -199.9 to 999.9°F	
		23	-150.0 to 150.0°C -199.9 to 300.0°F	
		24	-199.9 to 500.0°C -199.9 to 999.9°F	
		25	-199.9 to 500.0°C -199.9 to 999.9°F	
		26	-150.0 to 150.0°C -199.9 to 300.0°F	
		27	-199.9 to 500.0°C -199.9 to 999.9°F	
Standard signal	DC voltage	28	0.4 to 2 V 1 to 5 V	±0.1% of instrument range ±1 digit (Note) The read-out range can be scaled between -1999 and 9999.
		29	0 to 2 V 0 to 10 V	
		30	-10 to 20 mV 0 to 100 mV	
		31	0 to 2 V 1 to 5 V	
		32	0 to 2 V 0 to 10 V	
		33	-10 to 20 mV 0 to 100 mV	

* Performance in the standard condition (at 23±2°C, 55±10%RH, and 50/60Hz power frequency).
 Note1: The accuracy is ±0.3°C of instrument range ±1 digit for a temperature range from 0°C to 100°C.
 Note2: The accuracy is ±0.5°C of instrument range ±1 digit for a temperature range from -100°C to 0°C and 100°C to 200°C.
 * To receive a 4-20 mA DC signal, select a standard signal of 1 to 5 V DC and connect it to a 250Ω resistor. This resistor is optional.
 Model: X010-250-2 (resistor with M3.5 crimp-on terminal lugs)

NOTE

The indicator may automatically initialize the registered operating parameter setpoints if any change is made to the data item PV Input Type (IN), Maximum Value of PV Input Range (RH), Minimum Value of PV Input Range (RL), PV Input Decimal Point Position (SDP), Maximum Value of PV Input Scale (SH) or Minimum Value of PV Input Scale (SL). After a change has been made to any of these data items, be sure to verify the registered operating parameter setpoints to ensure that they are correct. If any data item has been changed to its default, set it to a required value.

3. Changing PV Input Type

The following operating procedure describes an example of changing the setting of K-type thermocouple (-199.9 to 500.0°C) to RTD Pt100 (-199.9 to 500.0°C) and a measurement range of 0.0 to 200.0°C.

1. Bring the operating display into view (display appears at power on).

2. Press the key for more than 3 seconds to call up the menu "OP.PA".

3. Press the key once to display the menu "STUP".

4. Press the key once to display the parameter "PWD".

5. Press the key once to display the menu "FUNC".

6. Press the key once to display the menu "I/O".

7. Press the key once to display the parameter "IN" (PV input type).

8. Press the or key to display the required setpoint. The figure below shows an example of changing to RTD Pt100 (-199.9 to 500.0°C).

9. Press the key once to register the setpoint.

10. Press the key once to display the parameter "UNIT" (PV input unit).

11. Press the key once to display the parameter "RH" (maximum value of PV input range).

12. Press the or key to display the required setpoint. The figure below shows an example of setting the maximum value of PV input range to 200.0°C.

13. Press the key once to register the setpoint.

14. Press the key once to display the parameter "RL" (minimum value of PV input range).

15. Press the or key to display the required setpoint. The figure below shows an example of setting the minimum value of PV input range to 0.0°C.

16. Press the key once to register the setpoint.

17. Press the key for more than 3 seconds. This returns you to the display shown at power-on (figure below).

18. If the type of input is voltage, also configure the PV Input Decimal Point Position (SDP), Maximum value of PV Input Scale (SH), and Minimum value of PV Input Scale (SL) parameters that are displayed after parameter RL.

4. Changing Alarm Type

The following operating procedure describes an example of changing alarm-1 (factory-set value: PV high limit alarm) to PV low limit alarm. When you have changed alarm type, the alarm setpoint will be initialized; set the alarm setpoint again.

Alarm output terminals	Factory-set defaults
Alarm-1 (terminal numbers ①-②)	PV high limit alarm
Alarm-2 (terminal numbers ③-④)	PV low limit alarm
Alarm-3 (terminal numbers ⑤-⑥)	PV high limit alarm
Alarm-4 (terminal numbers ⑦-⑧)	PV low limit alarm

1. Bring the operating display into view (appears at power-on).

2. Press the key for more than 3 seconds to call up the menu "OP.PA".

3. Press the key once to display the menu "STUP".

4. Press the key once to display the parameter "PWD".

5. Press the key once to display the menu "FUNC".

6. Press the key once to display the parameter "AL1" (alarm-1 type).

7. Press the or key to display the required setpoint. The figure below shows an example of setting PV low limit alarm.

8. Press the key once to register the setpoint.

9. Press the key for more than 3 seconds. This returns you to the display shown at power-on (figure below).

10. See "1. Setting an Alarm Setpoint" in **Operations User's Manual** when setting an alarm setpoint.

5. Setting Hysteresis in Alarm Setpoint

The following operating procedure describes an example of setting a 5.0°C hysteresis level in the alarm setpoint.

1. Bring the operating display into view (appears at power-on).

2. Press the key for more than 3 seconds to call up the menu "OP.PA".

3. Press the key once to display the menu "STUP".

4. Press the key once to display the parameter "PWD".

5. Press the key once to display the menu "FUNC".

6. Press the key several times to display the parameter "HY1" (alarm-1 hysteresis).

7. Press the or key to display the required setpoint.

8. Press the key once to register the setpoint.

9. Press the key for more than 3 seconds. This returns you to the display shown at power-on (figure below).

10. You can take the same steps for alarm-2 hysteresis (HY2), alarm-3 hysteresis (HY3), and alarm-4 hysteresis (HY4) that are displayed after this.

This manual describes key entries for operating the indicator. If you cannot remember how to carry out an operation during setting, press the key for more than 3 seconds. This brings you to the display (operating display) that appears at power-on.

Contents

1. Setting Alarm Setpoints
2. Troubleshooting

NOTE

Do not use the instrument generating strong magnetic field such as radio equipment and the like near the indicator. This may cause the fluctuation of the PV value.

1. Setting Alarm Setpoints

The following operating procedure describes an example of setting a value of 160.0 in the alarm 1 setpoint parameter. Before setting the alarm setpoint, check the alarm type. To change the alarm type, see "4. Changing Alarm Type" in **Initial Settings User's Manual**.

Alarm output terminals	Factory-set defaults
Alarm-1 (terminal numbers ⑥-⑦).....	PV high limit alarm
Alarm-2 (terminal numbers ⑤-⑦).....	PV low limit alarm
Alarm-3 (terminal numbers ④-⑦).....	PV high limit alarm
Alarm-4 (terminal numbers ①-②-③).....	PV low limit alarm

- Bring the operating display into view (display appears at power on).
- Press the key for more than 3 seconds to call up the menu "OP.PA".
- Press the key once to display the parameter "A1".
- Press the or key to display the required setpoint.
- Press the key once to register the setpoint.
- Press the key for more than 3 seconds. This returns you to the display shown at power-on (figure below).

You can take the same steps for alarm-2 setpoint (A2), alarm-3 setpoint (A3), and alarm-4 setpoint (A4) that are displayed after this.

2. Troubleshooting

Troubleshooting Flow

If the operating display does not appear after turning on the indicator's power, try to solve the problem by following the procedure below. If the problem seems to be complex, contact the vendor from which you purchased the instrument.

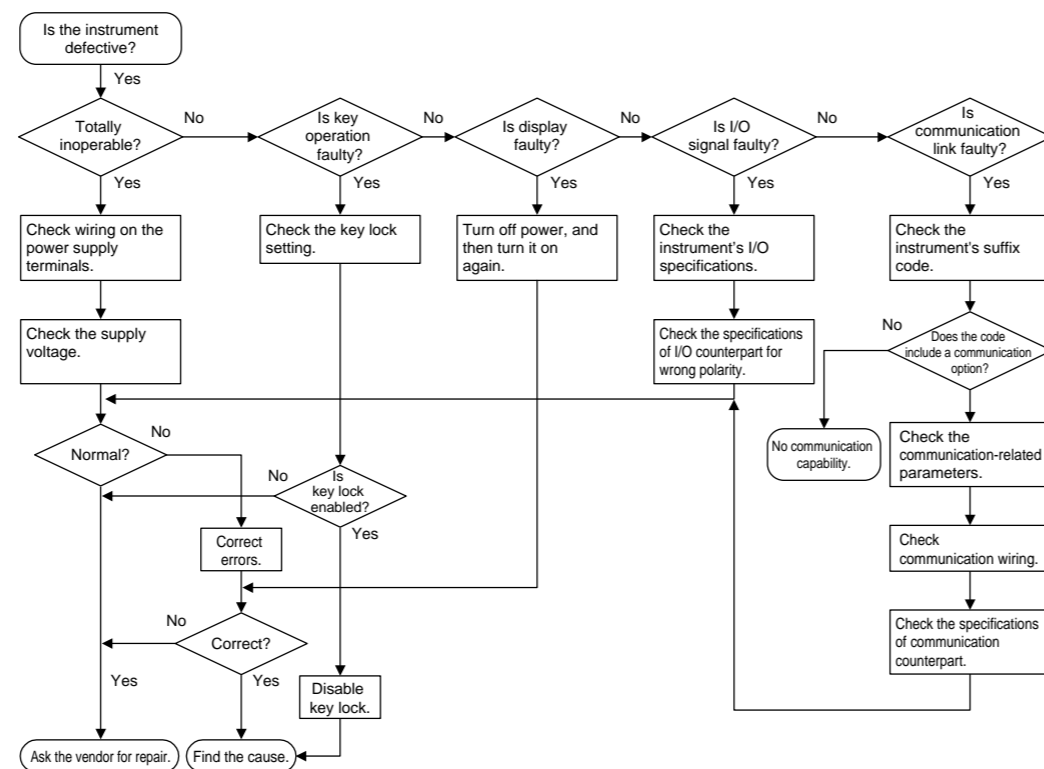

IMPORTANT

Take note of the parameter settings when asking the vendor for repair.

Errors at Power On

The following table shows errors that may be detected by the fault diagnosis function when the power is turned on.

Error indication (on PV display unit)	Description of error	PV	Control output	Alarm output	Retransmission output	Communication	Remedy
E000 (E000)	Faulty RAM	None	0% or less or OFF	OFF	0% or less	Stopped	Faulty Contact us for repair.
E001 (E001)	Faulty ROM	0%					
E002 (E002)	System data error	0%					
PV decimal point blinks.	Faulty calibration value	Normal action (out of accuracy)	Normal action (out of accuracy)	Normal action (out of accuracy)	Normal action (out of accuracy)	Normal action	
E400 (E400)	Parameter error	0%	Preset value	OFF	0%		Check and set the parameters, as they have been set to the limited values.

Possible Errors during Operation

The following shows possible errors occurring during operations.

Error indication (on PV display unit)	Description of error	PV	Control output	Alarm output	Retransmission output	Communication	Remedy
Displays "RJC" and PV alternately	RJC error	Measured with RJC=OFF	Normal action	Normal action	Normal action	Normal action	Faulty Contact us for repair.
PV value blinks.	EEPROM error	Normal action	Normal action	Normal action	Normal action	Normal action	Faulty Contact us for repair.
E300 (E300)	A/DC error	105%	Preset value	Normal action	Normal action	Normal action	
bOUT (B.OUT)	PV burnout error	Dependent on the BSL parameter Up-scale: 105% Down-scale: -5%	Preset value	Normal action	Normal action	Normal action	Check wires and sensor.
oVr (OVER) or -oVr (-OVER)	Excessive PV Out of -5 to 105%	-5% or 105%	Normal action	Normal action	Normal action	Normal action	Check process.
SP decimal point blinks (on setpoint display unit).	Faulty communication line	Normal action	Normal action	Normal action	Normal action	Normal action	Check wires and communication parameters, and make resetting. Recovery at normal receipt
All indications off	Runaway (due to defective power or noise)	None	0% or less or OFF	OFF	0% or less	Stopped	Faulty if power off/on does not reset start the unit. Contact us for repair.
All indications off	Power off	None	0%	OFF	0%	Stopped	Check for abnormal power.

If a Power Failure Occurs during Operation

- Momentary power failures shorter than 20 ms**
The indicator is not affected at all and continues normal operation.
- Momentary power failures of 20 ms or longer**
 - The alarm function of the indicator continues to work normally. (Alarms with the stand-by feature temporarily return to their stand-by state, however.)
 - Setting parameters that have already been configured retain their settings.

This manual contains a parameter map as a guideline for setting parameters, and lists of parameters for recording User Settings.

Contents

- 1. Basic Key Operation Sequence and Parameter Map
- 2. Lists of Parameters

1. Basic Key Operation Sequence and Parameter Map

If you become unsure of key operation during parameter setting, hold down the key for more than 3 seconds. This returns you to the display at power-on (i.e., operating display).

- Basic Key Operation Sequence
- Setting display can be switched (moved) using the key.
 - A numerical value is changed by
 - Using the or key to change a displayed value (decimal point blinking) and
 - Pressing the key to register it.
 - Pressing the key on an operating display (for more than 3 seconds) brings you to the operating parameter setting display.
 - Pressing the key on the operating parameter setting display (for more than 3 seconds) returns you to the operating display.
 - Pressing the key on the setup parameter setting display (for more than 3 seconds) returns you to the operating display. You cannot return to the operating parameter setting display from the setup parameter setting display.

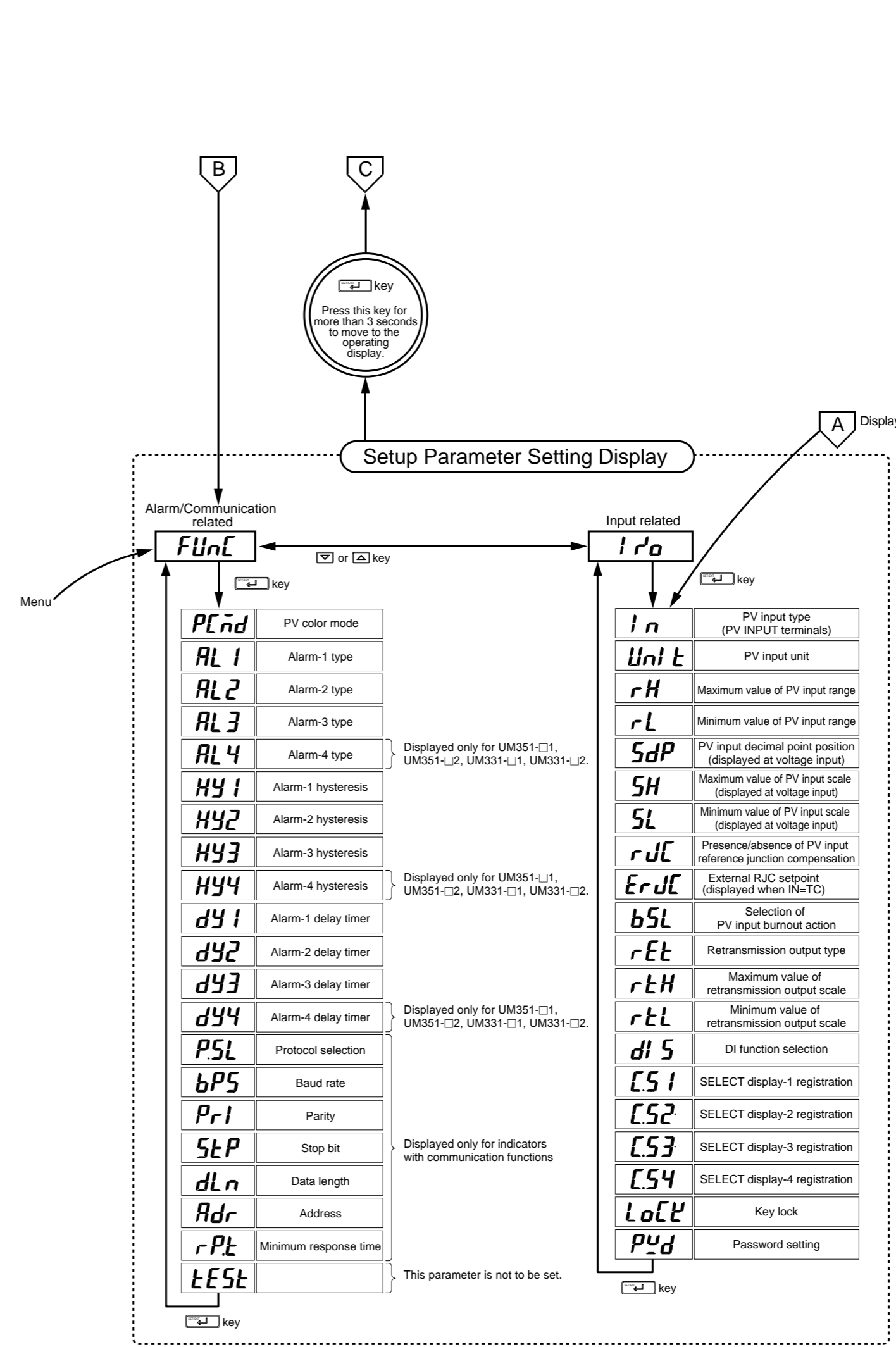
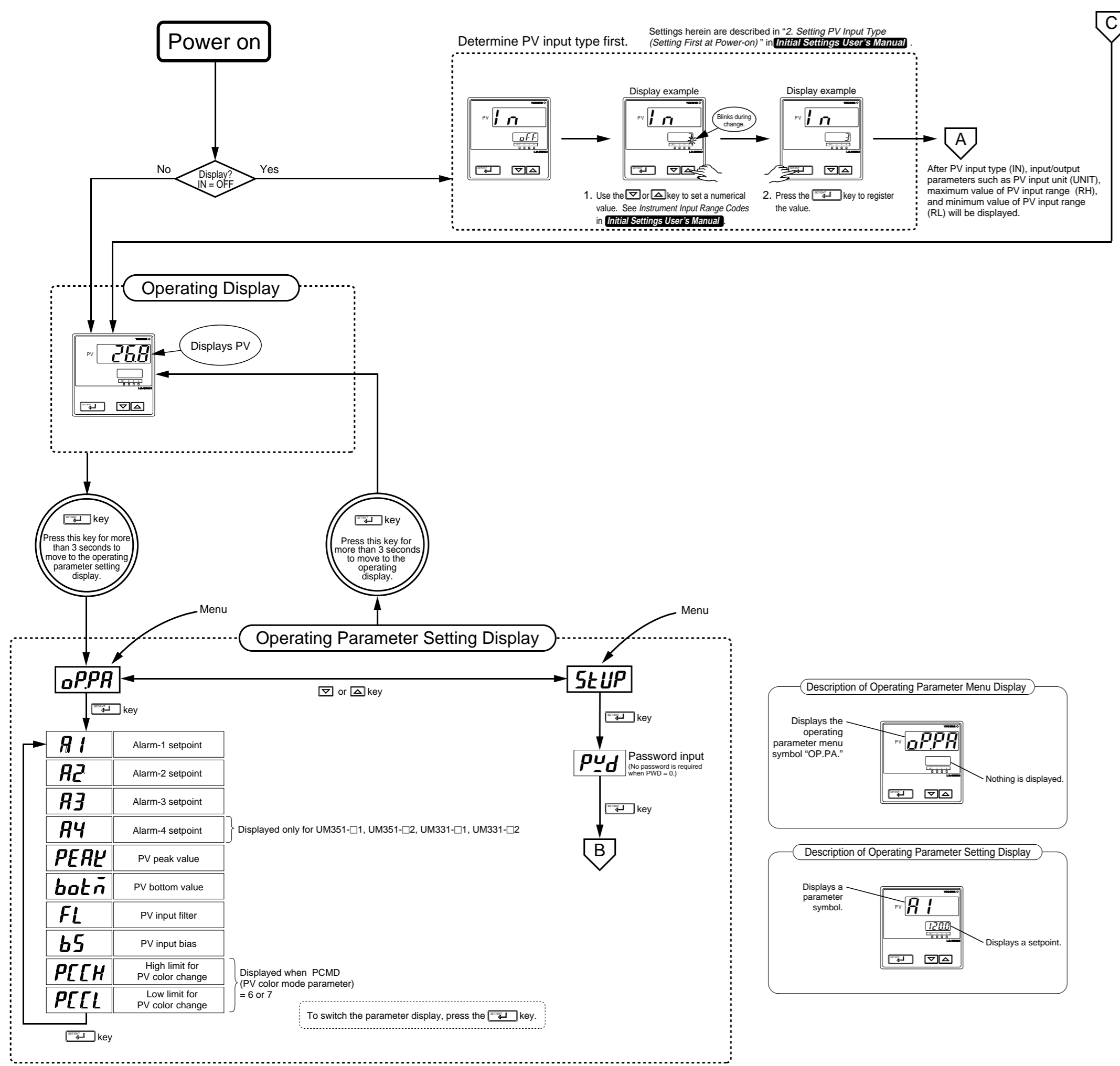

NOTE
Changing the registered value of a setup parameter may cause the registered value of an operating parameter to be initialized automatically. Thus, when you have changed a setup parameter, always check that the registered value of the operating parameter is appropriate. If it is initialized to default, reset it to the required value.

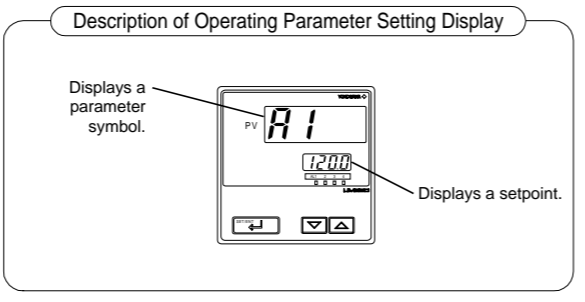
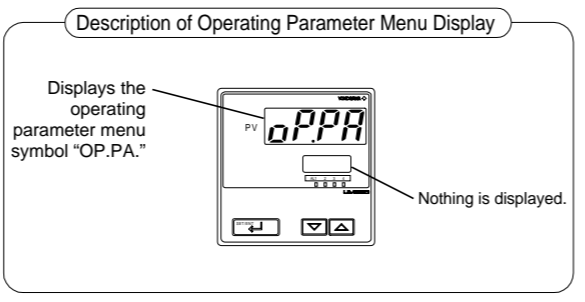
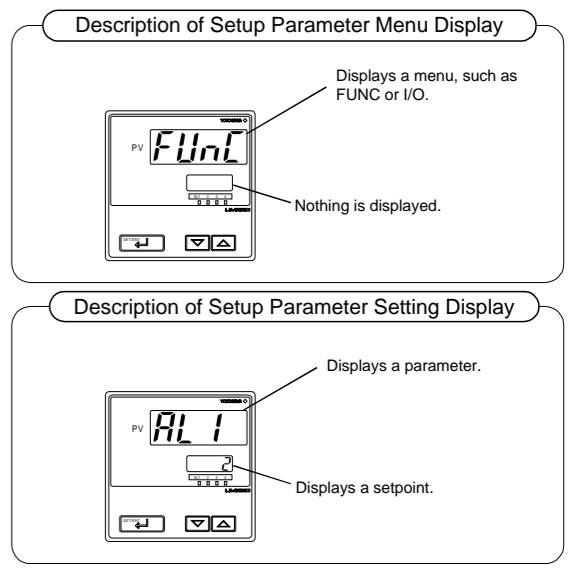

2. Lists of Parameters

* Parameters relating to PV should all be set in real numbers. For example, use temperature values to define alarm setpoints for temperature input.

Operating Parameters

Parameter Symbol	Name of Parameter	Setting Range and Description	Initial Value	User setting
R1 (A1)	Alarm 1-setpoint	PV alarm: -100.0 to 100.0% of PV input range PV high limit alarm: 100.0% of PV input range PV low limit alarm: 0.0% of PV input range		
R2 (A2)	Alarm 2-setpoint			
R3 (A3)	Alarm 3-setpoint			
R4 (A4)	Alarm 4-setpoint			
PEAK (PEAK)	PV peak value	Displays the maximum value of PV input during operation. This parameter is not to be set.		
botn (BOTM)	PV bottom value	Displays the minimum value of PV input during operation. This parameter is not to be set.		
FL (FL)	PV input filter	OFF, 1 to 120 second Used when the PV input fluctuates.	OFF	
bs (BS)	PV input bias	-100.0% to 100.0% of PV input range span Used to correct the PV input value.	0.0% of PV input range span	
PCCH (PCCH)	High limit for PV color change	When PCMD (PV color mode parameter) = 6 or 7 : -100.0 to 100.0 % of PV input range	When PCMD = 6 or 7 : PCCH = 100.0% , PCCL = 0.0 %	
PCCL (PCCL)	Low limit for PV color change			

Setup Parameters

Alarm/Communication-related Parameters

Parameter Symbol	Name of Parameter	Setting Range and Description	Initial Value	User setting
PCMD (PCMD)	PV color mode	0: Fixed in green 1: Fixed in red 2: Link to alarm 1 (Alarm OFF:green, Alarm ON:red) 3: Link to alarm 1 and 2 (Alarm OFF:green, Alarm ON:red) 4: Link to alarm 1 and 2 (Alarm ON:red, Alarm OFF:green) 5: PV limit (Within PV range:green, Out of PV range:red) 6: PV limit (Within PV range:green, Out of PV range:red) 7: PV limit (Within PV range:red, Out of PV range:green)	1	
AL1 (AL1)	Alarm-1 type	OFF 1: PV high limit (energized, no stand-by action) 2: PV low limit (energized, no stand-by action) 9: PV high limit (de-energized, no stand-by action) 10: PV low limit (de-energized, no stand-by action) 11: PV high limit (energized, stand-by action) 12: PV low limit (energized, stand-by action) 19: PV high limit (de-energized, stand-by action) 20: PV low limit (de-energized, stand-by action) 21: Fault diagnosis output Turns on in case of input burnout, A/D converter failure, or reference junction compensation (RJC) failure. 22: FAIL output Turns off in case of program failure, ROM failure, RAM failure, or power failure. This output is on during normal operation. If it turns off, the retransmission output is set to 0%, the alarm output is set to OFF, and the indicator stops. See "List of Alarm Types" on the right side of this manual for details on how these Alarm Type parameters behave.	1	
AL2 (AL2)	Alarm-2 type		2	
AL3 (AL3)	Alarm-3 type		1	
AL4 (AL4)	Alarm-4 type		2	
HY1 (HY1)	Alarm-1 hysteresis	0.0 to 100.0% of PV input range span	0.5% of PV input range span	
HY2 (HY2)	Alarm-2 hysteresis	Hysteresis can be set in the alarm setpoint. Setting hysteresis prevents relays from chattering.		
HY3 (HY3)	Alarm-3 hysteresis	Hysteresis setting for PV high limit alarm Output Point of on-off action (Alarm setpoint) On Off Hysteresis PV value		
HY4 (HY4)	Alarm-4 hysteresis			
DY1 (DY1)	Alarm-1 delay timer	An alarm is output when the delay timer expires after the alarm setpoint is reached. 0.00 to 99.59 (min, sec.) (enabled when alarm-1 type "AL1" is 1, 2, 9, 10, 11, 12, 19, and 20)	0.00	
DY2 (DY2)	Alarm-2 delay timer	0.00 to 99.59 (min, sec.) (enabled when alarm-2 type "AL2" is 1, 2, 9, 10, 11, 12, 19, and 20)		
DY3 (DY3)	Alarm-3 delay timer	0.00 to 99.59 (min, sec.) (enabled when alarm-3 type "AL3" is 1, 2, 9, 10, 11, 12, 19, and 20)		
DY4 (DY4)	Alarm-4 delay timer	0.00 to 99.59 (min, sec.) (enabled when alarm-4 type "AL4" is 1, 2, 9, 10, 11, 12, 19, and 20)		
PSL (P.SL)	Protocol selection	0: PC link communication 1: PC link communication (with sum check) 2: Ladder communication 7: MODBUS (ASCII) 8: MODBUS (RTU)	0	
BPS (BPS)	Baud rate	0: 600, 1: 1200, 2: 2400, 3: 4800, 4: 9600 (bps)	4	
PR1 (PR1)	Parity	0: None 1: Even 2: Odd	1	
STP (STP)	Stop bit	1, 2	1	
DLN (DLN)	Data length	7, 8 Fixed at 7, when the P.SL parameter is set to MODBUS (ASCII). Fixed at 8, when the P.SL parameter is set to MODBUS (RTU) or Ladder Communication.	8	
ADR (ADR)	Address	1 to 99 However, the maximum number of stations connectable is 31.	1	
RPT (RPT)	Minimum response time	0 to 10 (× 10 ms)	0	
TEST (TEST)	If this parameter symbol appears, press the SET/ENT key to return to the FUNC menu. Caution: Do not change the setpoint of the TEST parameter, otherwise the indicator will be disabled.			

* The "User Setting" column in the table below is provided for the customer to record setpoints.

Input-/Output-related Parameters

Parameter Symbol	Name of Parameter	Setting Range and Description	Initial Value	User Setting
IN (IN)	PV input type (PV INPUT terminals)	OFF, 1 to 18, 30, 31, 35 to 37, 40, 41, 50, 51, 55, 56 See Instrument Input Range Codes in Initial Settings User's Manual	OFF	
Unit (UNIT)	PV input unit	°C: degree Celsius °F: Fahrenheit	°C	
RH (RH)	Max. value of PV input range	Set the PV input range, however RL < RH -Temperature input Set the range of temperature that is actually indicated. -Voltage input Set the range of a voltage signal that is applied. The scale across which the voltage signal is actually indicated should be set using the parameters Maximum Value of PV Input Scale (SH) and Minimum Value of PV Input Scale (SL).	Max. value of instrument input range	
RL (RL)	Min. value of PV input range		Min. value of instrument input range	
SDP (SDP)	PV input decimal point position (displayed at voltage input)	0 to 3 Set the position of the decimal point of voltage-mode PV input. 0: No decimal place 1: One decimal place 2, 3: Two, three decimal places	1	
SH (SH)	Max. value of PV input scale (displayed at voltage input)	-1999 to 9999, however SL < SH Set the read-out scale of voltage-mode PV input.	100.0	
SL (SL)	Min. value of PV input scale (displayed at voltage input)		0.0	
BSL (BSL)	Selection of PV input burnout action	OFF 1: Up scale 2: Down scale	1	
RJC (RJC)	Presence/absence of PV input reference junction compensation	OFF, ON	ON	
ERJC (ERJC)	External RJC setpoint	-50.0 to 50.0 °C -58.0 to 122.0 °F	0.0 °C 32.0 °F	
RET (RET)	Retransmission output type	1: PV 4: Loop power supply for sensor (15 V)	1	
RTH (RTH)	Max. value of retransmission output scale	RET=1: RTL + 1 digit to 100.0% of PV input range	100.0% of PV input range	
RTL (RTL)	Min. value of retransmission output scale	RET=1: 0.0% of PV input range to RTH - 1 digit	0.0% of PV input range	
DIS (DIS)	DI function selection	OFF: The external contact input is disabled. 1: Resets the values of the PEAK and BOTM operating parameters to an off-to-on transition of the DI input.	1	
C.S1 (C.S1)	SELECT display-1 registration	OFF, 201 to 1015 For example, registering "231" for C.S1 allows you to change alarm-1 setpoint in operating display.	OFF	
C.S2 (C.S2)	SELECT display-2 registration	Numbers for registering alarm SP parameter for operating display: Alarm-1 setpoint: 231 Alarm-2 setpoint: 232 Alarm-3 setpoint: 233 Alarm-4 setpoint: 234		
C.S3 (C.S3)	SELECT display-3 registration			
C.S4 (C.S4)	SELECT display-4 registration			
LOCK (LOCK)	Key lock	OFF: No key lock 1: Change to any parameter prohibited Prohibits any operating parameter or setup parameter from being changed. The setpoint of the LOCK parameter itself can be changed, however. 2: Change to and display of operating parameters prohibited Turns off the display for setting operating parameters, thus prohibiting any change to the parameter settings. (Press the SET/ENT key for more than 3 seconds to show the password check display.)	OFF	
PWD (PWD)	Password setting	0: Password not set 1 to 9999	0	

List of Alarm Types

The table below shows the alarm types and alarm actions.

In the table, codes 1, 2, 9, and 10 are not provided with stand-by actions, while codes 11, 12, 19, and 20 are provided with stand-by actions.

Alarm type	Alarm action	Alarm type code	Alarm type	Alarm action	Alarm type code
No alarm	Hysteresis "Open/close" shows status of relay contact, and "lit" and "unlit" shows status of lamp	OFF	No alarm	Hysteresis "Open/close" shows status of relay contact, and "lit" and "unlit" shows status of lamp	9
PV high limit	Open (unlit) / Closed (lit) PV Alarm setpoint	11	De-energized on PV high limit	Closed (unlit) / Open (lit) PV Alarm setpoint	19
PV low limit	Closed (lit) / Open (unlit) Alarm setpoint / PV	2	De-energized on PV low limit	Open (lit) / Closed (unlit) Alarm setpoint / PV	10
Fault diagnosis output (Note1)		21	FAIL output (Note2)		22

Note1: Fault diagnosis output

Turns on in case of input burnout, A/D converter failure, or reference junction compensation (RJC) failure.

Note2: FAIL output

Turns off in case of program failure, ROM failure, RAM failure, or power failure. This output is on during normal operation. If it turns off, the retransmission output is set to 0%, the alarm output is set to OFF, and the indicator stops.

Stand-by Action

It is effective in the following cases where:
- the power is turned on
- the alarm type is changed

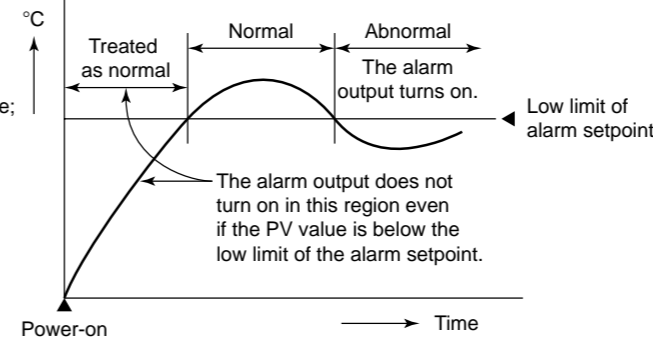

Behavior of the PV High-limit Alarm Parameter (Alarm Type Code: 1)

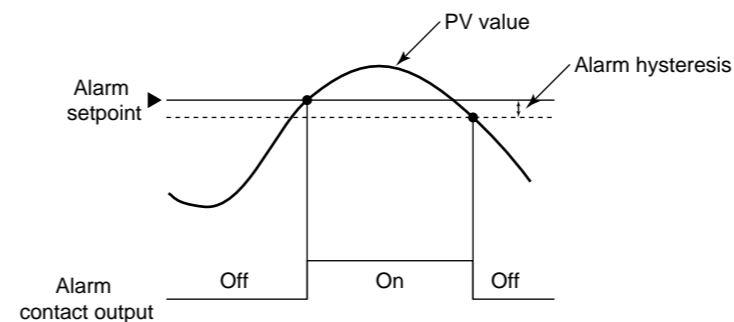

Useful Operating Display (SELECT Display)

Registering frequently changed parameters in the SELECT display after ordinary operating displays will allow you to change settings easily. A maximum of four displays can be registered.

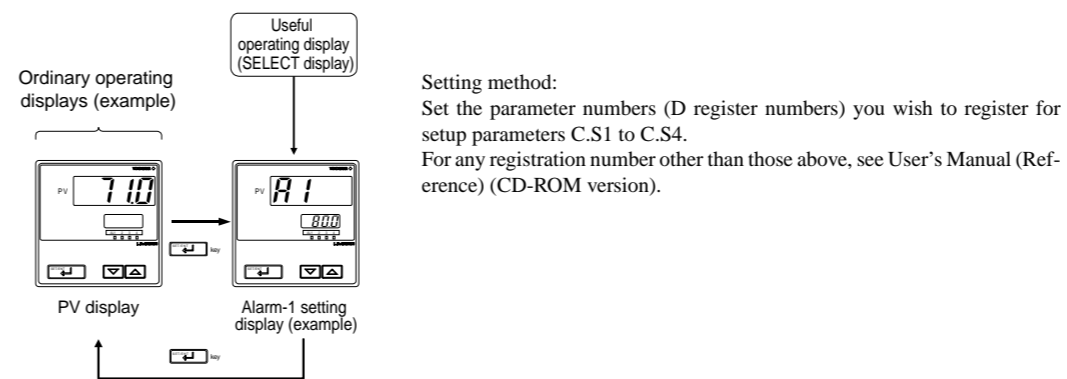

Numbers for Registration with SELECT Display

Operating Parameter	Registration Number	Setup Parameter	Registration Number
Alarm-1 setpoint (A1)	231	Alarm-1 hysteresis	919
Alarm-2 setpoint (A2)	232	Alarm-2 hysteresis	920
Alarm-3 setpoint (A3)	233	Alarm-3 hysteresis	921
Alarm-4 setpoint (A4)	234	Alarm-4 hysteresis	922
Bias (BS)	243		
Filter (FL)	244		













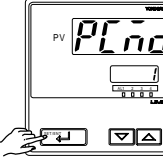

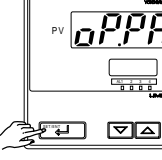

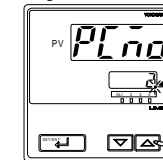
This manual describes the PV display color changing function "Active Color PV Display."

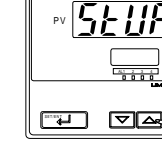
Carry out settings according to the following procedures after referring to "Functions of Active Color PV Display" on the back of this manual. Use "Parameter Map" of Parameters User's Manual to understand the required parameters. If you cannot remember how to carry out an operation during setting, press the  key for more than 3 seconds. This brings you to the display (operating display) that appears at power-on. The UT321 is identical to the UM351/UM331 in items of front panel operation.

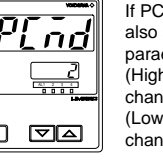
■ Setting the PV display color changing function "Active Color PV Display"

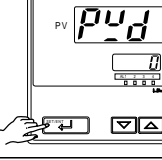
The following operating procedure describes an example of changing PV color mode (factory-set default: Fixed in red mode) to Link to alarm 1 mode.

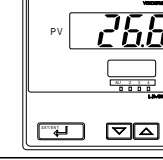

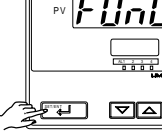





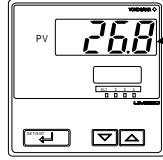

Parameter Symbol	Name of Parameter	Setting Range	Initial Value
PCMD (PCMD)	PV color mode	0 : Fixed in green 1 : Fixed in red 2 : Link to alarm 1 (Alarm OFF:green, Alarm ON: red) 3 : Link to alarm 1 (Alarm OFF:red, Alarm ON:green) 4 : Link to alarm 1 and 2 (Alarm OFF:green, Alarm ON:red) 5 : Link to alarm 1 and 2 (Alarm OFF:red, Alarm ON:green) 6 : PV limit (Within PV range:green, Out of range:red) 7 : PV limit (Within PV range:red, Out of range:green)	1

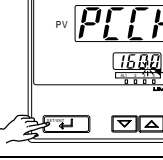
(1) Bring the operating display into view (appears at power on).  Displays PV.	(6) Press the  key several times to display the menu "PCMD" (PV color mode).  Displays parameter "PCMD"
(2) Press the  key for more than 3 seconds to call up the menu "OP.PA."  Displays menu "OP.PA"	(7) Press the  key or  key to display the required setpoint. The figure below shows an example of setting Link to alarm 1 mode.  Blinks during change.
(3) Press the  key once to display the menu "STUP."  Displays menu "STUP"	(8) Press the  key once to register the setpoint.  If PCMD = 6, 7, 8 or 9, also set the relating parameters PCCH (High limit for PV color change) and PCCL (Low limit for PC color change).
(4) Press the  key once to display the parameter "PWD."  Displays menu "PWD"	(9) Press the  key for more than 3 seconds. This returns you to the display shown at power-on (figure blow).  Displays PV.
(5) Press the  key once to display the menu "FUNC."  Displays menu "FUNC"	

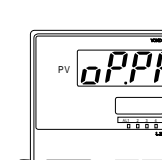
■ Setting the High Limit and Low limit for PV Color change

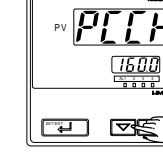
The following operating procedure describes an example of changing PV display color by linking to PV. Set High limit and Low limit for PV color change. Setting for both of High limit and Low limit is required.

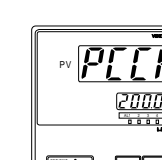
Parameter Symbol	Name of Parameter	Setting Range	Initial Value
PCCH (PCCH)	High limit for PV color change	When PCMC (PV color mode parameter) = 6 or 7: -100.0 to 100.0 % of PV input range.	When PCMD = 6 or 7: PCCH:100.0 %, PCCL:0.0 %
PCCL (PCCL)	Low limit for PV color change		

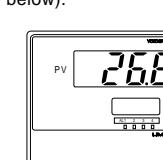
(1) Bring the operating display into view (appears at power-on).  Displays PV.	(4) Press the  key or  key to display the required setpoint.  Blinks during change.
(2) Press the  key for more than 3 seconds to call up the menu "OP.PA."  Displays menu "OP.PA"	(5) Press the  key once to register the setpoint.  PCCL (Low limit for PV color change parameter) that is displayed after this can be
(3) Press the  key several times to display the parameter "PCCH."  Displays parameter "PCCH."	(6) Press the  key for more than 3 seconds. This returns you to the display shown at power-on (figure below).  Displays PV.

Functions of Active Color PV Display

This part describes the functions of "Active Color PV Display." PV display color is changed by the following four actions.

PV display is selectable from red-to-green or green-to-red changing action, or fixed color.

Link to alarm 1 mode (when PCMD = 2, 3) (Setting example-1)

Link to alarm 1 and 2 mode (when PCMD = 4, 5) is the same. When either of the alarms occurs, the display color is changed.

PV limit mode (when PCMD = 6, 7) (Setting example-2)

Fixed color mode (when PCMD = 0, 1) (Setting example-3)

Setting Example-1 : Link to Alarm

Works linked to alarm 1.
Set "PV high limit alarm" for alarm 1 type, and "80°C" for alarm 1 setpoint.
If PCMD (PV color mode parameter) = 2, PV display color is changed from green to red when PV input value exceeds alarm 1 setpoint.
The red-to-green changing action is selectable.
Setting parameters
PCMD (PV color mode parameter) = 2
AL1 (Alarm 1 type parameter) = 1
A1 (Alarm 1 setpoint parameter) = 80°C
HY1 (Alarm 1 hysteresis parameter) = 5°C

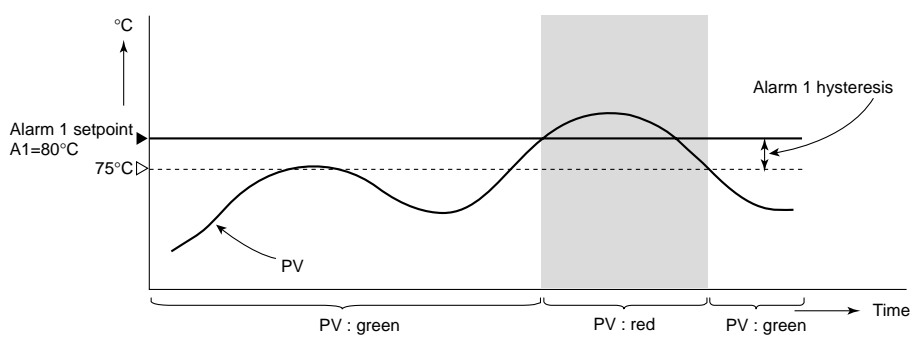

Setting Example-3 : Fixed in Red or Green

Set the PV display color or Fixed in green mode, Setting of Fixed to red mode is also possible.
Setting parameter
PCMD (PV color mode parameter) = 0

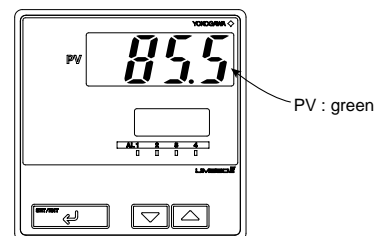

Setting Example-2 : Link to PV

Set high limit "70°C" for PCCH, and low limit "20°C" for PCCL.
PV display color is changed from green to red when PV input value is out of the range.
The red-to-green changing action is selectable.
Setting parameters
PCMD (PV color mode parameter) = 6
PCCH (High limit for PV color change parameter) = 70°C
PCCL (Low limit for PV color change parameter) = 20°C
Hysteresis fixed to 0.25% is inserted where PV display color is changed.
In the example blow, where changed from red to green.

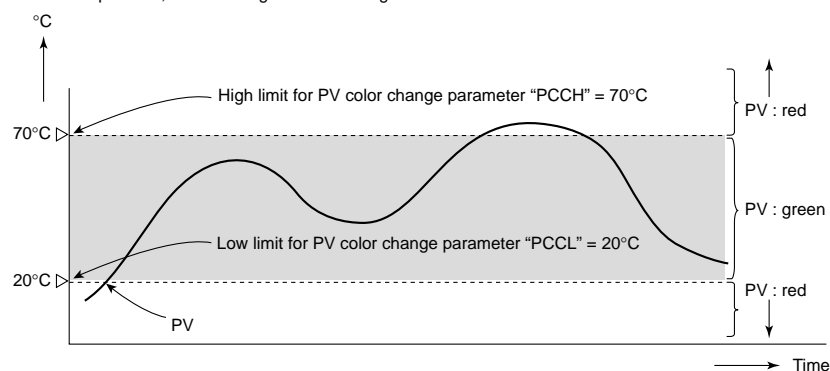

External RJC

External RJC is not a compensation function built in an indicator but a compensation function working outside the indicator.

External RJC is used when input is thermocouple, and RJC=OFF.

Using External RJC makes the accuracy of RJC higher and shortens the compensating wire.

Parameter Symbol	Name of Parameter	Setting Range	Initial Value
ERJC (ERJC)	External RJC setpoint	-50.0 to 50.0°C, -58.0 to 122.0°F For thermocouple input, temperature compensation value outside the indicator can be set. Available only when RJC=OFF.	0.0°C 32.0°F

